



Purge and Pressurization Systems
for Hazardous Locations



Model AFP-01 Installation & Operations Manual

Contact Us
Tel: 716.500.abco

ab-copurge.com

IOM-AFP/1

Table of Contents

Purpose and Functions	3
Warnings	4-6
Special Considerations	7
Industry Specifications	8
AFP-01 Basic Specifications	9
AFP-01 Dimensional Drawings	10
AFP-01 Components.....	11-13
Customer-Supplied Tubing Requirements	14
Installation Instructions.....	15-25
Operational Instructions	26-33
Maintenance.....	34
Website Access to Product Data Sheets.....	35
AFP-01 Control Panel Instructions	36
AFP-01 Product Configuration Code.....	37
AB-CO PURGE System Checklist.....	38
Appendix	39
UL Certification.....	39A
FM Certification	39B
Warning Labels - French Language.....	39C
Warranty Statement	40

AFP-01 – Purpose and Function

The AB-CO PURGE AFP-01 Purge and Pressurization System is designed specifically for electrical enclosures with volumes up to 15 cubic feet (0.42 cubic meters) that are used in hazardous environments and that do not meet explosion proof or intrinsically safe criteria. The AFP-01 supplies the enclosure with the proper amount of inert gas or clean instrument air which removes concentrations of combustible material from the enclosure and prevents the accumulation of this material within the enclosure. When properly installed and operated, the system provides a sustained positive pressure, relative to the ambient pressure outside the enclosure, of 0.15 inches of water to 0.35 inches of water. These limits are inside those prescribed by NFPA 496 which requires the protected enclosure be constantly maintained at a positive pressure of at least 25 Pa (0.1 inches of water) above the surrounding atmosphere during operation of the protected equipment. In accordance with this standard, the protected equipment can be energized once an enclosure pressure of at least 25 Pa exists, and the atmosphere within the enclosure is known to be below the ignitable concentration of the combustible material.

The AFP-01 has an analog enclosure pressure gauge that provides a visual indication of the differential pressure within the enclosure versus the ambient pressure outside the enclosure. The flow of protective gas into the electrical enclosure can also reduce problems such as heat, moisture, dust, and corrosion within the enclosure. Effective operation of the AFP-01 purge and pressurization system requires an exchange of four (4) enclosure volumes of inert gas or clean instrument air **at a flow rate of 6 cubic feet/minute** before the protected enclosure is allowed to be energized. For motors, generators, and other rotating electrical machinery, the system requires an exchange of ten (10) enclosure volumes of inert gas or clean instrument air **also at a flow rate of 6 cubic feet/minute**. The times are so indicated on the front of the system's control panel. These systems are also provided with a vent which acts as a relief valve to ensure the enclosure is not over pressured.

If required, an explosion proof pressure switch is available which can provide additional visual and/or audio indication of a loss of purge pressure within the enclosure.

As a Y-Type purge and pressurization system, the AFP-01 systems reduce the classification within the electrical enclosure used in a Class I or Class II hazardous environment from Division 1 to Division 2.

As a Z-Type purge and pressurization system, the AFP-01 systems reduce the classification within the electrical enclosure used in a Class I or Class II hazardous environment from Division 2 to unclassified.

The AFP-01 is certified for Class II atmospheres where the particle density is less than 130 lb/ft³ (2083 kg/m³) or specific gravity less than 2.083. In accordance with Table 6.2.4 of NFPA 497:2017, dust particles with densities greater or equal to 130 lb/ft³ (2083 kg/m³) or specific gravity greater less than 2.083 require a higher enclosure pressure which is outside the scope of this certification.

The AFP-01 units are designed to meet the requirements of NFPA 496:2017(Standard for Purged and Pressurized Enclosures for Electrical Equipment), UL508, 17th Edition (Standard for Industrial Control Equipment), CSA C22.2, No. 14 – 13, 12th Edition (CSA Standard for Industrial Control Equipment).

BODILY INJURY OR DEATH WARNINGS



Read and understand this manual before attempting to install, operate, or service this purge and pressurization system. Failure to do so can cause bodily injury or death.

The purchaser is solely responsible for ensuring that their system, including the electrical enclosure, is in conformance with applicable codes. This manual only covers the general applicability of the AB-CO PURGE Type-Y or Type-Z purge and pressurization systems and relief valves. Specific installation must be approved by the governing code body or bodies.

This purge and pressurization system is only one component of a “Purged and Pressurized Electrical Equipment” installation. The complete system installation shall be in accordance with the current issue of the National Electrical Code NFPA-70 and in accordance with the current issue of the National Fire Protection Agency NFPA-496.

ADDITIONAL SAFETY WARNINGS



Note the following warnings located on warning labels must be applied to the exterior of the electrical enclosure in a easy to see location:



“WARNING – PRESSURIZED ENCLOSURE – This enclosure must not be opened unless the area atmosphere is known to be below the ignitable concentration of combustible materials or unless all devices within have been de-energized.”



If protective gas other than air is used, the following warning will be located on the electrical enclosure:

“WARNING – Protective Gas Release Poses Potential for Asphyxiation”



For enclosures used in Class II hazardous environments, the following warning label is provided and must be applied to the electrical enclosure:

“WARNING – Power must not be restored after the enclosure has been opened until combustible dusts have been removed and the enclosure repressurized.”

ADDITIONAL SAFETY WARNINGS ...continued



Install this warning label to the enclosure in a readily visible location.
(Refer to page 23 for how to calculate minimum fast purge times)

Please Note:

1. For Y-Type Purge and Pressurization applications, warning labels applied to the protected enclosure must be metal. The metal warning labels are included with the installation kit.

2. For Z-Type Purge and Pressurization applications, warning labels applied to the protected enclosure are metalized adhesive labels. These labels are included with the installation kit.



Note:
For UL certified units, with applications in Canada, a French Language Warning Label will be included in the installation kit. See page 39D in the appendix.

See page 23 for examples on how to calculate purge times
User to permanently inscribe number of minutes in this space

Figure F-1
Warning Label
to be installed on the enclosure
in a readily visible location
(Label included in the AFP-01 installation kit)

ADDITIONAL SAFETY WARNINGS ...continued



Example of Installation of the warning label to the enclosure in a readily visible location.



Figure F-1
Warning Label
to be installed on the enclosure
in a readily visible location
(Label included in the AFP-01 installation kit)

SPECIAL CONSIDERATIONS

READ AND UNDERSTAND THIS MANUAL BEFORE ATTEMPTING TO INSTALL, OPERATE, OR SERVICE THIS AFP-01 PURGE/PRESSURIZATION SYSTEM

The AFP-01 unit must be placed in a readily accessible and visible location.

Non-explosive, non-corrosive purge (protective) gas must be supplied to the AFP-01 unit. The protective gas shall be essentially free of contaminants or foreign matter and shall contain no more than trace amounts of flammable vapor or gas within the pressure range of 60 psig to 195 psig and at an appropriate rate consistent with the specifications for the AFP-01.

The AFP-01 is a fast purge system and the purged enclosure must be provided with a minimum of one (1) relief valve (vent). (See Figure F-6 on page 18 for vent configurations) The purged enclosure must be capable of withstanding a minimum of 0.4 psi (11.1 inch of water) differential pressure during the fast purge cycle.

Over-tightening the enclosure pressure control valve (“D” in Figure F-3 and Figure R-1 is a fine-adjust needle valve) into it’s soft seat or over-tightening the fittings into the fast purge pressure regulator (“A” in Figure F-3 and Figure R-1) will irreversibly damage your AFP-01 unit and void the warranty.

Use backup wrenches when tightening the inlet and outlet fitting for the enclosure. These fittings are supplied by AB-CO PURGE in the installation kit.



Figure F-1
Inlet and Outlet Fittings
for Electrical Enclosure
(Included with AFP-01 Installation Kit)

Routine operational checks of the AFP-01 system and it’s components are required. It is recommended that these operational performance checks be done at least monthly. More frequent checks are best determined by the user who is aware of the operational use and environment. Any adjustments should only be made in accordance with procedures outlined in this manual.

The AFP-01 is certified for Class II atmospheres where the particle density is less than 130 lb/ft³ (2083 kg/m³) or specific gravity less than 2.083. In accordance with Table 6.2.4 of NFPA 497:2017, dust particles with densities greater or equal to 130 lb/ft³ (2083 kg/m³) or specific gravity greater less than 2.083 require a higher enclosure pressure which is outside the scope of this certification.

INDUSTRY SPECIFICATIONS



NFPA 496:2017

“Purged and Pressurized Enclosures for Electrical Equipment” 1 – 2017 Edition.

UL508, 17th Edition

“Standard for Industrial Control Equipment”

CSA C22 2, No. 14-13, 12th Edition

“Canadian Standards Association Standard for Industrial Control Equipment”



AFP-01 Basic Specifications



Z-Purge Version:

Suitable for up to fifteen (15) cubic foot (0.42 cubic meters) volumes for Class I, Division 2, Groups A, B, C, D and Class II, Division 2, Groups F and G.

(See pages 20 and 21 when optional pressure switch is used)

Y-Purge Version:

Suitable for up to fifteen (15) cubic foot (0.42 cubic meters) volumes for Class I, Division 1, Groups A, B, C, D and Class II, Division 1, Groups F and G.

(See pages 20 and 21 when optional pressure switch is used)

Outlet to enclosure ¼-inch tube fitting: Use ¼-inch OD x 0.035-inch stainless steel Tubing

Required input flow capability: Twenty (20) SCFM (Standard Cubic Feet per Minute)

Protective Gas Minimum Flow Rate (after enclosure is closed and prior to being energized):
6 SCFM (Standard Cubic Feet per Minute)

Fast Purge Flow Rate: 1 minute/1.5 cubic feet of enclosure volume (1 minute/0.6 cubic feet for motors, generators, and other rotating electric machinery.)
(NOTE: For AFP-01, the fast purge time is to be filled in by the user on the warning label, Fig. F-1, provided with the installation kit).

Continuous flow rate: 0.5 to 30 SCFH (Standard Cubic Feet per Hour)

Connections: Supply fitting into the enclosure for the AFP-01 is a ¼" FNPT
The outlet fitting from enclosure to the AFP-01 is ¼" tube fitting
Reference lines are ¼" stainless steel tubing with 0.035" wall.

Purge Gas Supply: The instrument air or inert gas used as purge air should have a pressure that does not exceed 195 psig and it is recommended the pressure be about 100 psig. The inlet pressure should never be less than 60 psig. The supply of protective gas shall be essentially free of contaminants of foreign matter and shall contain on more than trace amounts of flammable vapor or gas.

AFP-01 Components - Front View

The following pages of the manual will refer to each of these components by the name and number as designated on this figure (Figure F-3).

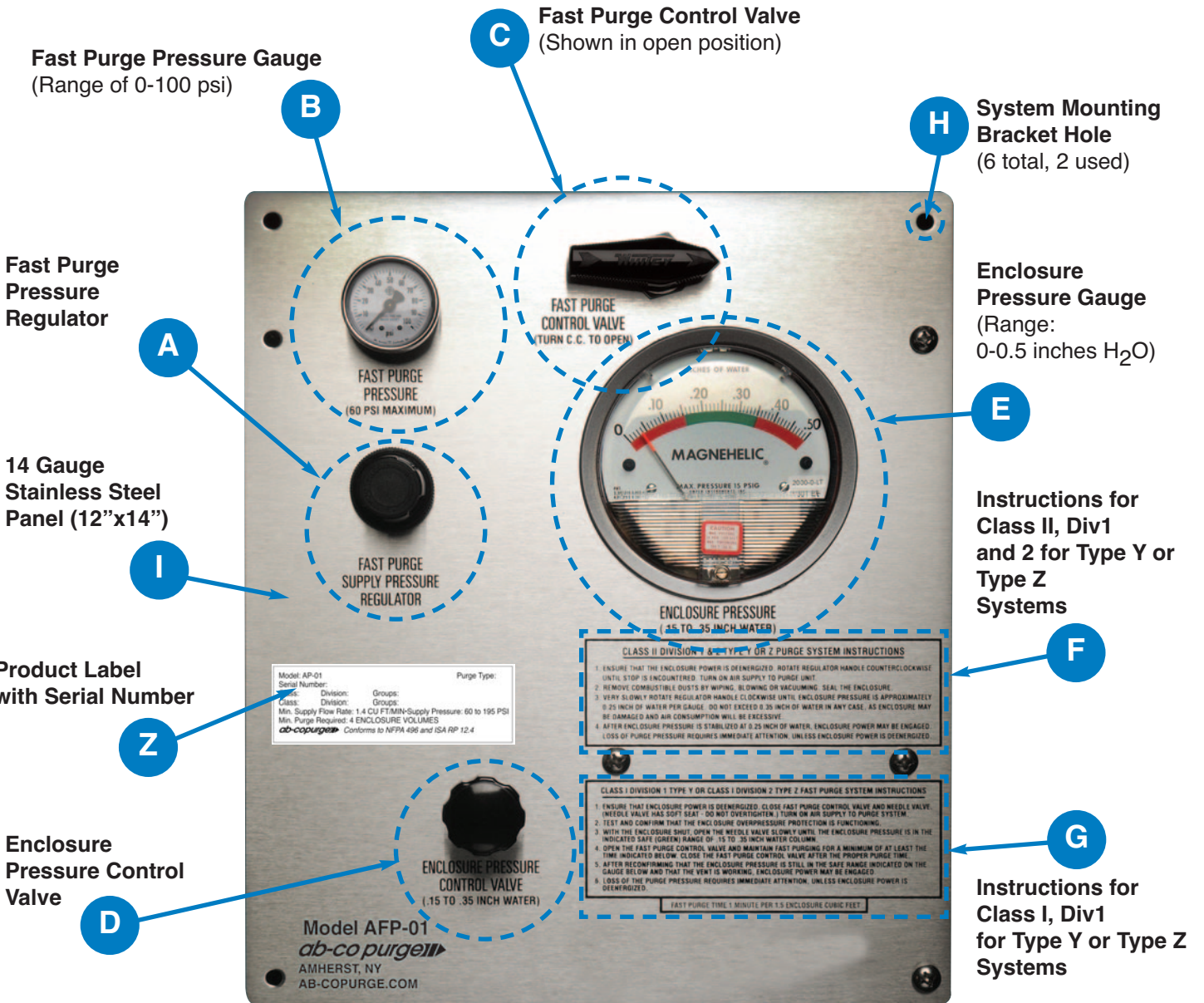

Figure F-3

AFP-01 Components - Rear View

The following pages of the manual will refer to each of these components by the name and number as designated on this figure (Figure R-1).

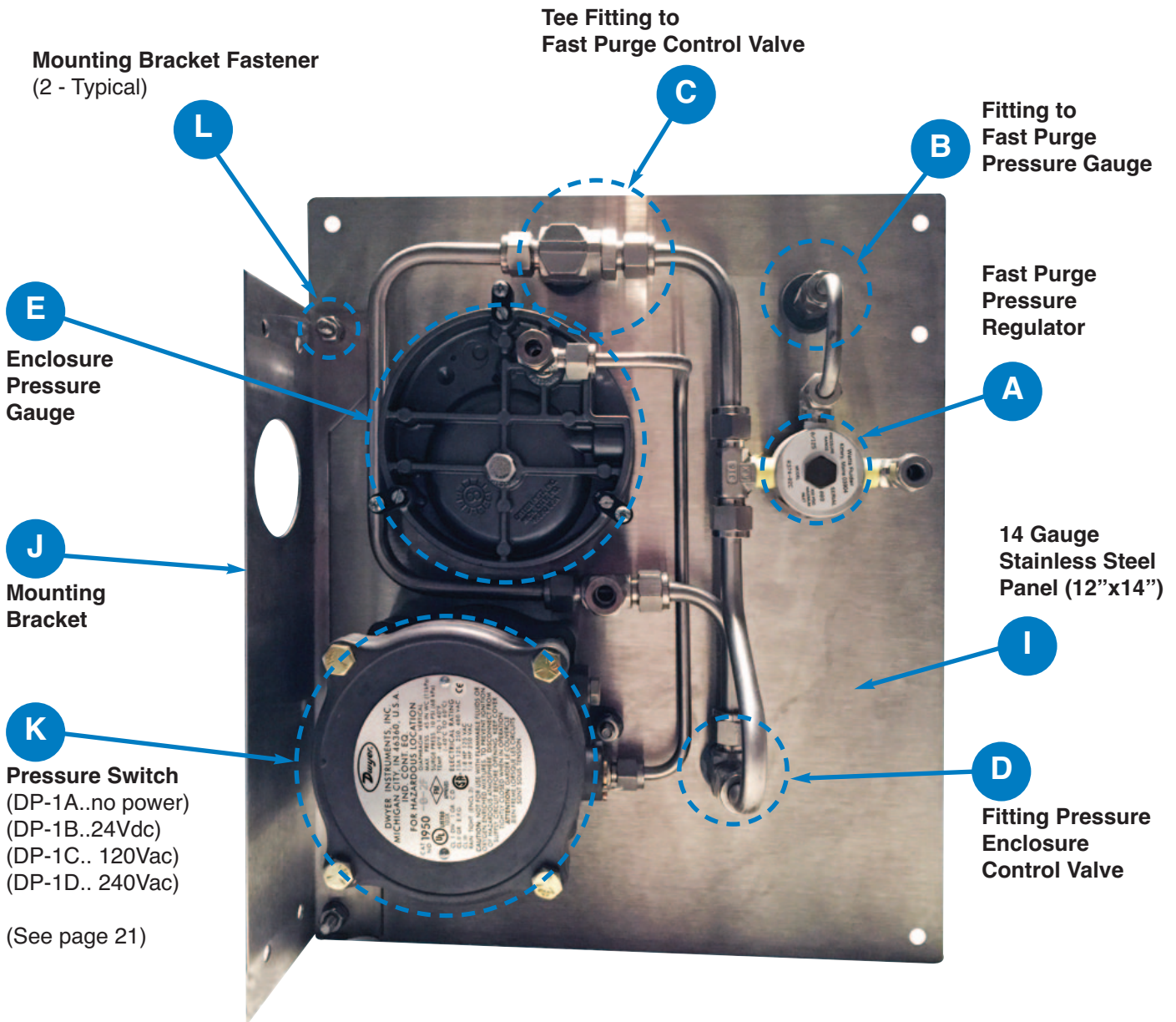

Figure R-1

AFP-01 Components

Stainless Steel Tubing/Fitting - Layout

1/4" SS Tube from Fast Purge Valve to Tee to **Customer Furnished 1/4" SS Tube** into Electrical Enclosure Fitting

T-2 1/4" SS Tube from Fast Purge Pressure Regulator to Fast Purge Valve

T-1 1/4" SS Tube from Fast Purge Pressure Regulator to Fast Purge Gauge

Customer Furnished 1/4" SS Tube out of Electrical Enclosure Fitting to 1/4" SS Tee into Enclosure Pressure Gauge

Clean Instrument Air or Inert Gas Supply from **Customer** to Fast Purge Pressure Regulator

Customer Furnished 1/4" SS Tube into Electrical Enclosure Fitting from 1/4" SS Tee

T-6 1/4" SS Tube from Pressure Switch to Enclosure Pressure Gauge (Only when using optional pressure switch)

Mounting Bracket Attached to Electrical Enclosure

J

T-5 1/4" SS Tube from Pressure Enclosure Control Valve to Tee to **Customer Furnished 1/4" SS Tube** into Electrical Enclosure Fitting

T-4 1/4" SS Tube from Fast Purge Pressure Regulator to Pressure Enclosure Control Valve

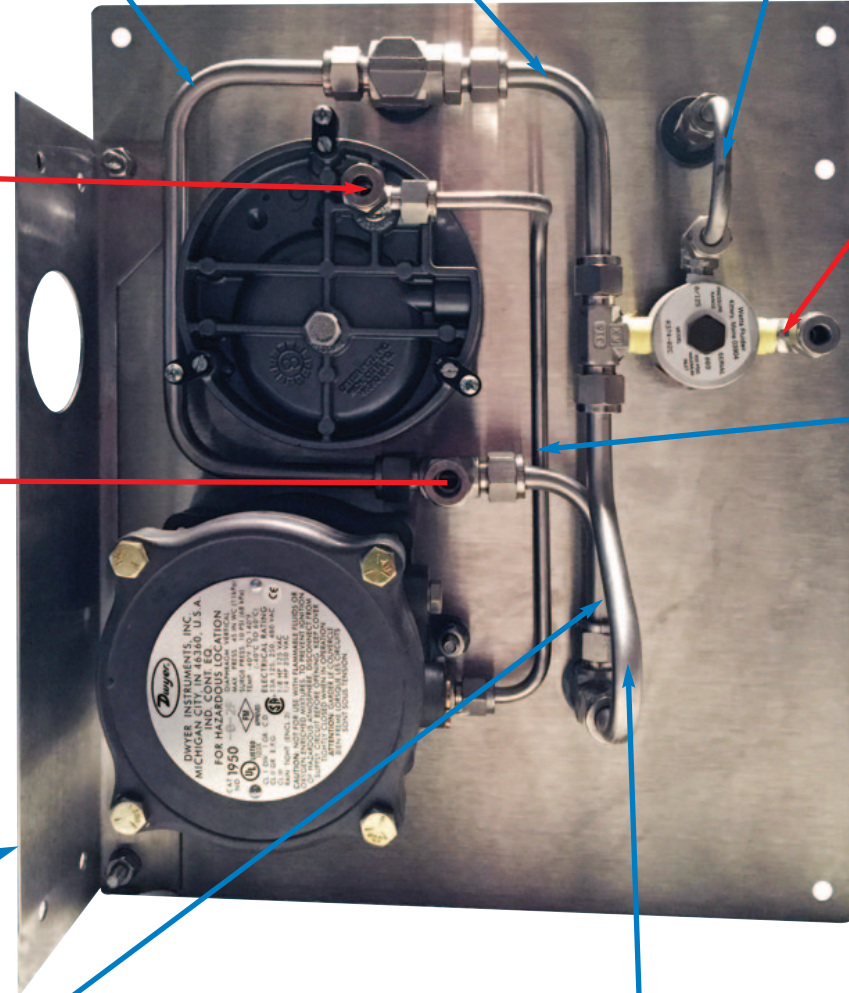

Figure R-2

AFP-01 Components

Customer Supplied Tubing Requirements

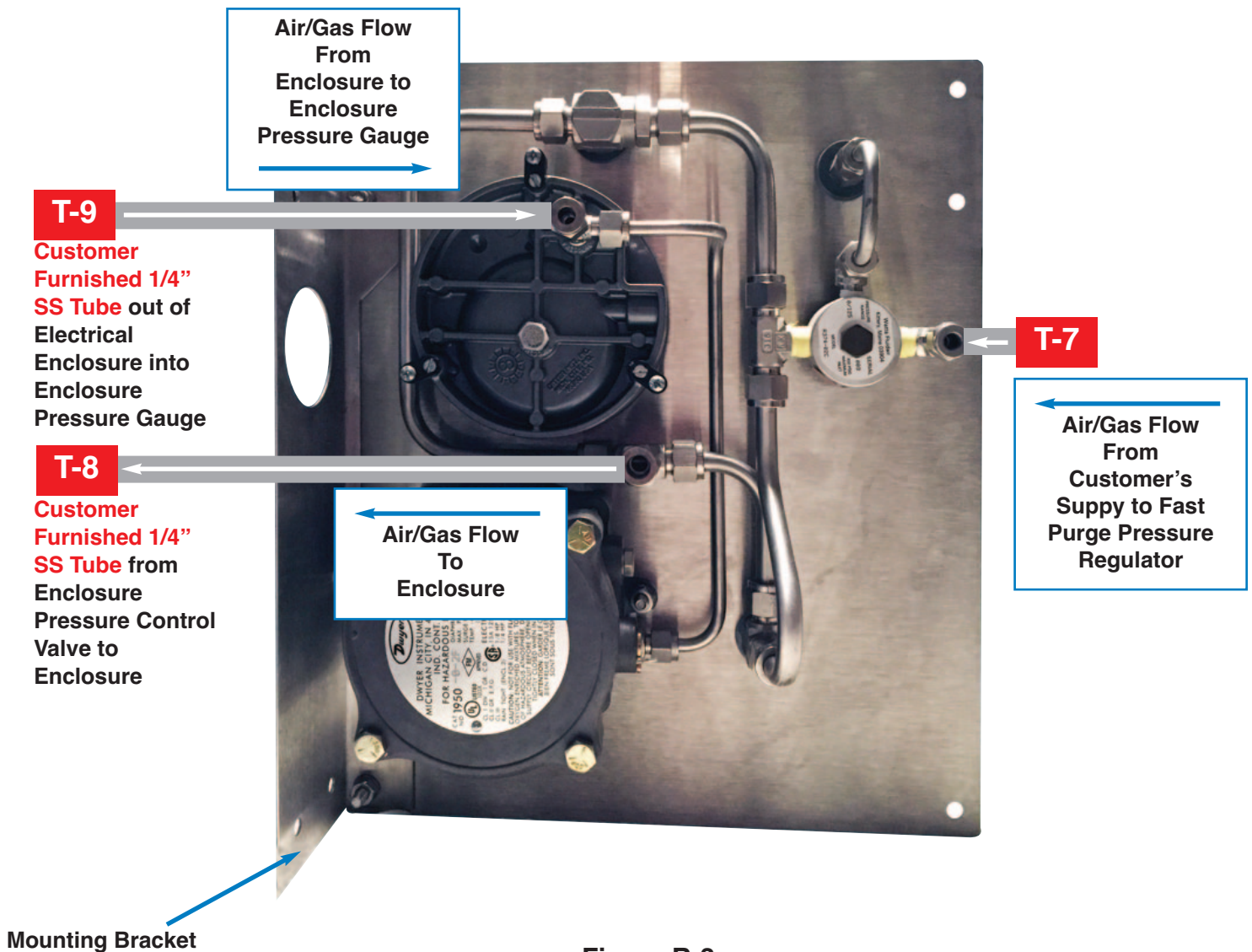

Figure R-3
(T-7, T-8, and T-9
tubing supplied by customer)

Note: The above configuration shows the mounting bracket (“J”) on the right side of the AFP-01 panel (if looking at it from the front). Thus, the AFP-01 would be mounted on the front left side of the electrical enclosure. For left-sided, top, and bottom mounts, “T-8”, and “T-9” customer furnished tubing would still be routed to the electrical enclosure and from the electrical enclosure to the enclosure pressure gauge (“E”) respectively. “T-7” tubing would be supplied by the customer from the air/gas supply to the fast purge pressure regulator (“A”).

INSTALLATION



The purchaser is solely responsible for ensuring that their system, including the electrical enclosure, is in conformance with applicable codes. These instructions only cover the general applicability of the AB-CO PURGE Type-Y or Type-Z purge and pressurization systems and relief valves. Specific installation must be approved by the governing code body or bodies.

Enclosure

Before an enclosure can be considered satisfactorily purged, it must meet certain criteria:

1. The enclosure meets either NEMA 4 or NEMA 12 specifications
2. The enclosure must be able to withstand a minimum internal pressure of 0.4 psig (11.1 inches of water) without distortion or other damage to itself or other components. With the fast purging function, it is very important that the enclosure withstand this internal pressure because the vent (relief valve) has a combined flow restriction slightly less than 0.4 psig.

NOTE: The AFP-01 must be placed in a readily accessible and visible location.

This is essential in order to allow the operator to visually confirm the functionality of the purge system. If the visual indicator (enclosure pressure gauge -- “E” in Figure F-3) is not readily visible during normal operating conditions, the optional pressure switch (“K” in Figure R-1) is required to provide remote annunciation.

Step I-1



The installer must ensure the electrical enclosure is de-energized – there must be no power into the enclosure. AB-CO PURGE suggests that the customer has an effective “Lock-Out/Tag-Out” system in place in order to ensure all safety precautions are addressed.

Step I-2

A. Prepare the electrical enclosure for installing the stainless steel tube fittings and attaching the AFP-01. The installation kit provided with the AFP-01 includes two 1/4” stainless steel fittings for the instrument air/gas into the enclosure and air/gas out of the enclosure. (See Figure F-4 below.)



Figure F-4
1/4” Stainless Tube Fittings
Supplied with AFP-01
Installation Kit

INSTALLATION

The 4 mounting holes in the universal mounting bracket are 10 ¼" x 1 ½" apart
All mounting holes are 9/32" diameter. (Figure F-5 below.)

Note: The universal mounting bracket is provided with the AFP-01 and interfaces with the front panel



Figure F-5
Universal Mounting Bracket
showing location of 4 of
9/32" OD mounting holes

B. We suggest mounting the AFP-01 to the electrical enclosure first. This will help determine the optimum location for drilling the holes for the ¼" tube fittings (Figure F-4; Supplied with the installation kit) required for air/gas into and out of the enclosure. This helps ensure there are no interferences on the inside wall of the enclosure. Since the customer can best determine what type of mounting hardware to use, ***the customer supplies the fasteners for attaching the AFP-01 mounting bracket to the electrical enclosure.***

C. The AFP-01 should be installed as close to the enclosure as practical in order to avoid excessive pressure drops. The air/gas supply line into the fast purge pressure regulator ("**A**") should be of adequate capacity for the AFP-01. Customer furnished tubing is to be ¼" stainless tubing (0.035" wall) and associated fittings of the same size as the recommended outlet size.

Note: AB-CO PURGE can provide additional sections of straight stainless tubing if this is convenient for the customer.

INSTALLATION

Step I-3

A. Drill the required holes for 1/4" stainless steel fittings to be used for enclosure's input and output tubing. These fittings are included with the AFP-01's installation kit (Figure F-4). If the hazardous environment consists of concentrations of combustible gas which are lighter than air, then the input fitting should be located toward the bottom and near one corner of the enclosure. If the hazardous environment consists of concentrations of combustible gas which are heavier than air, the inlet fitting should be located toward the top and near one corner of the enclosure.

Note: Ensure the locations for both the inlet fitting and outlet fitting do no interfere with the four (4) mounting bracket holes.

B. With inlet and outlet fitting installed in the enclosure, mount the AFP-01 system to the enclosure using the mounting hardware supplied with the system's installation kit. Even though the mounting bracket is already fastened to the 14"x12" stainless steel panel ("I" in Figure F-3 and Figure R-1), the mounting bracket can be installed on either side of the panel or the top or bottom of the panel. (See Figure R-4 below.)

Stainless steel mounting bracket attached to panel. The other 90° leg is fastened to the enclosure.

(The mounting bracket can be mounted to either side of the stainless steel panel or to the top or bottom of the of the panel. This allows the AFP-01 to be installed to the right-side, left-side, top, or bottom of the enclosure)

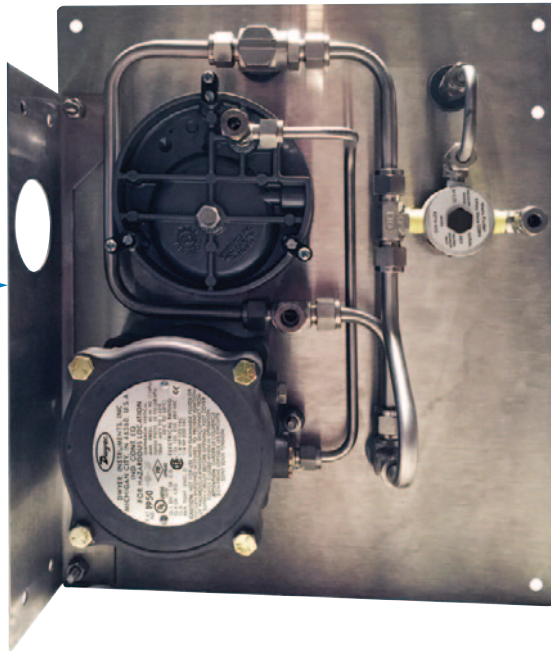

14 Gauge stainless steel panel (12 x 14")

Figure R-4



(Front view Of AFP-01 attached to an enclosure)

INSTALLATION

Step I-4

A. A vent (pressure control valve) installed in the electrical enclosure is required for AFP-01 system installations. During proper application, the vent ensures that the enclosure is not over-pressurized. There are two versions of the vent used with the AFP-01 (see Figure F-6 below and dimensional drawings on the following page.)

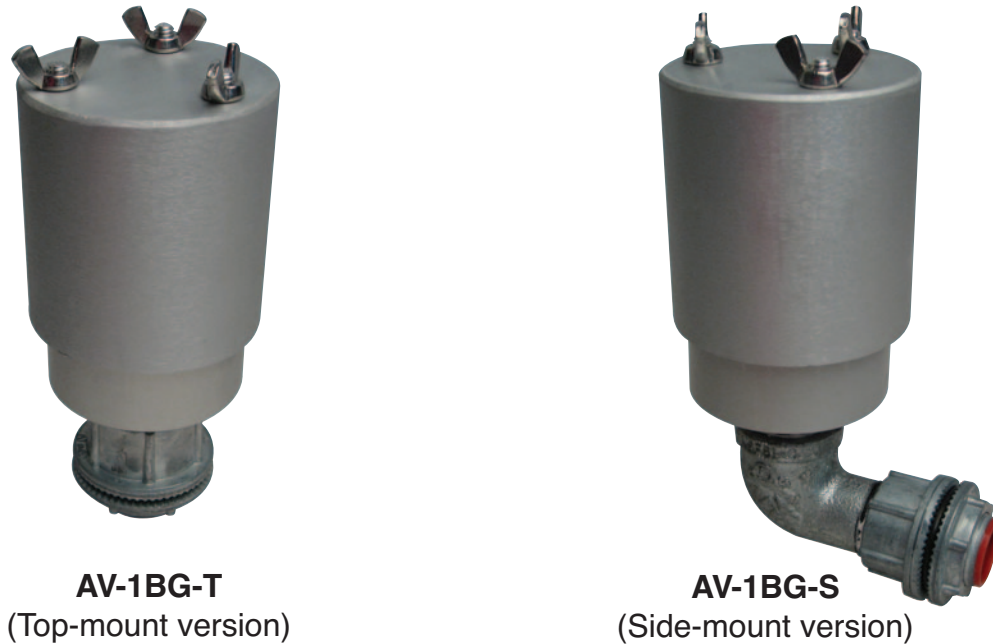
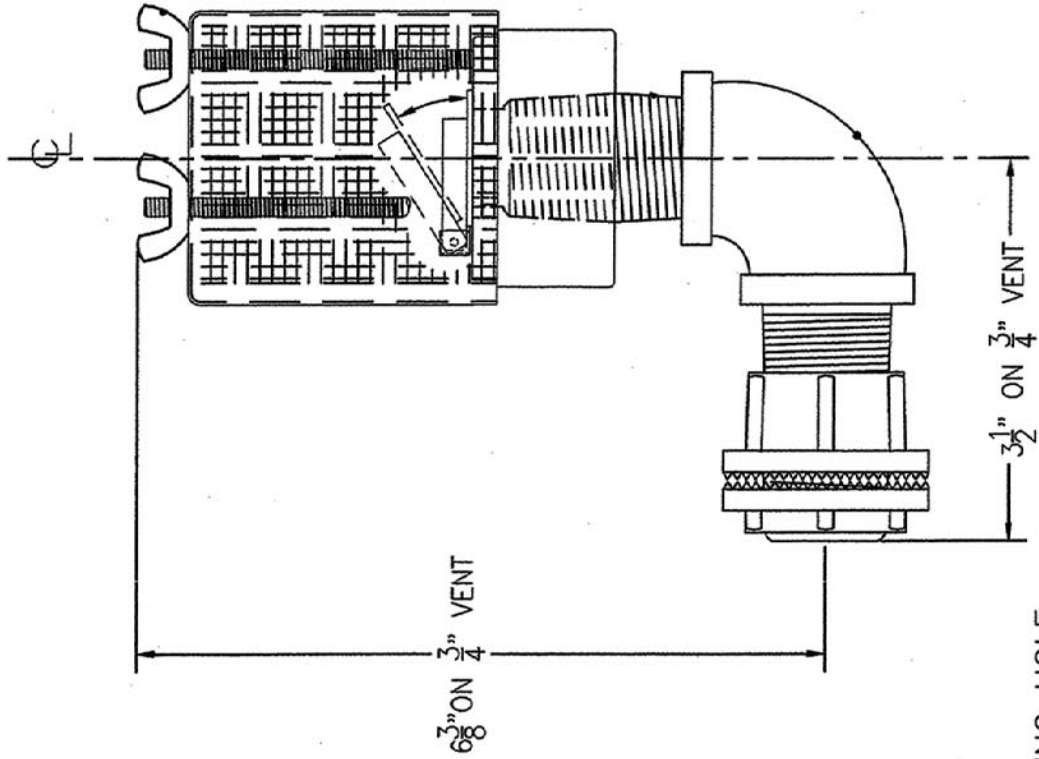

Figure F-6

B. The vent is mounted with the hub-type connector provided with the vent assembly. Make a 1-1/16" diameter vent mounting hole in the enclosure. The vent must be mounted with its axis vertical in order to ensure proper functioning. The vent also protects the enclosure in the event the Enclosure Pressure Control Valve ("D" in Figure F-3) is opened too much.

Note: It is best to locate the vent mounting hole diagonally opposite the inlet fitting installed for the AFP-01 panel.

AFP-01 Dimensional Drawings



TYPICAL SIDE MOUNT ARRANGEMENT

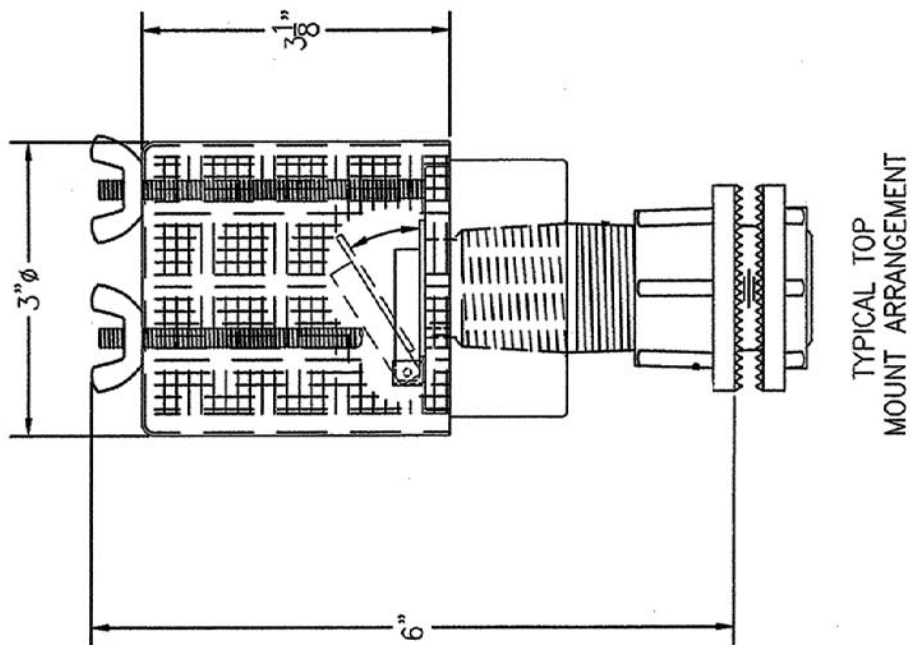

NOTES: — 3/4" VENT REQUIRES A 1/16" ϕ MOUNTING HOLE

INSTALLATION for Pressure Switch

Step I-5

Note: For installations requiring UL certification, a pressure switch is required.
(For all other certifications, a pressure switch is an option)

A. The pressure switch provides for alarm capability allowing an electrical output that can be used to provide a visual or audible signal that is intended to attract attention.

B. The pressure switch is a differential pressure device which compares the protected enclosure pressure with ambient hazardous environment pressure and is designed to activate an additional alarm (visual or audible) indication when positive pressure inside the enclosure has dropped below 0.15 inches of water (or customer safety set-point).

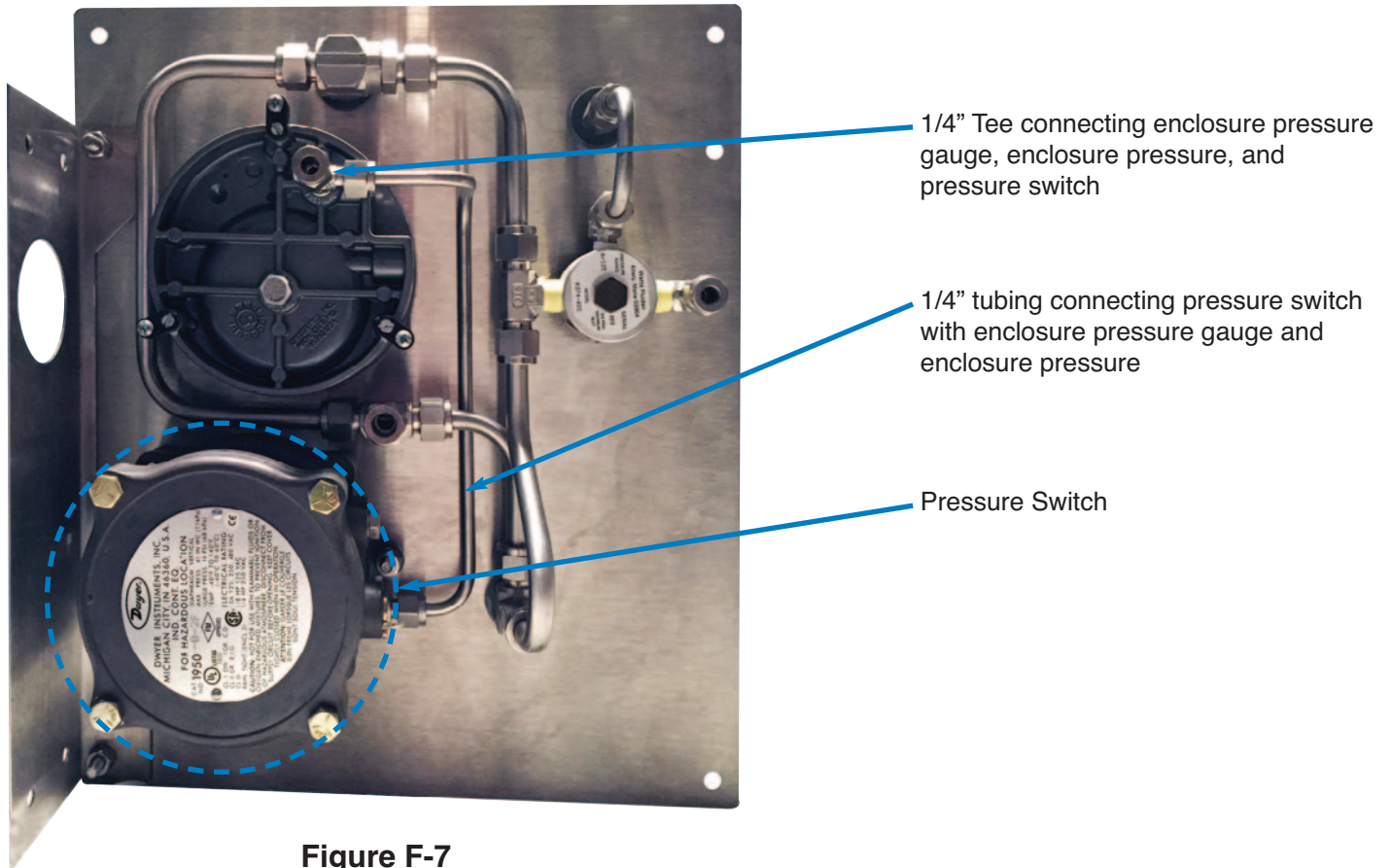

Figure F-7

C. There are four different versions of the pressure switch, depending on switch type, power requirements to the switch, and signal out connections.

Model	Type of Switch	Supply Power	Signal Out	Class/Group Rating
DP-1A	Mechanical (Diaphragm)	N/A	Yes	Class I/ C & D Class II/ F & G
DP-1B	Electronic (Hall-Effect Sensor)	24 Vdc	Yes	Class I/ A, B, C, & D Class II/ F & G
DP-1C	Electronic (Hall-Effect Sensor)	120 Vac	Yes	Class I/ A, B, C, & D Class II/ F & G
DP-1D	Electronic (Hall-Effect Sensor)	240 Vac	Yes	Class I/ A, B, C, & D Class II/ F & G

INSTALLATION for Pressure Switch

- D. If there is power to the pressure switch, the installer/operator determines if both supply power (DC or AC) and signal will be connected from within the enclosure or from outside the enclosure.
- E. To make electrical connections, remove the three hex head screws from the pressure switch cover and after loosening the fourth captive screw, swing the cover aside. Electrical connections to the standard single pole, double throw relay
- F. **For DP-1A Pressure Switch** (Mechanical diaphragm type):
Certified for Class I, Groups C & D, and Class II, Groups F & G
No input power is required. The output signal wires are connected to the pressure switch internal terminal strip (See Figure R-5 below). This differential pressure switch has an internal diaphragm that activates a relay when pressure set-point shows loss of enclosure pressure below a safe level.
- G. **For DP-1B Pressure Switch** (Electronic Hall-Effect sensor):
Certified for Class I, Groups A, B, C, & D and Class II, Groups F & G
Supply power is 24 VDC. Electrical connection to the standard single pole, double throw relay and DC supply voltage connections to the switch are provided by means of terminals marked "COM", "NO", "NC", "+", and "-" (See Figure R-6 below.)
The normally open contacts close and the normally closed contacts open when pressure exceeds the setpoint.
- H. **For DP-1C and DP-1D Pressure Switches** (Electronic Hall-Effect sensor):
Certified for Class I, Groups A, B, C, & D and Class II, Groups F & G
Supply power is 120 VAC for the DP-1C and 240 VAC for the DP-1D. Electrical connections to the standard single pole, double throw relay and AC supply voltage connections to the switch are provided by means of terminals marked "COM", "NO", "NC", "~", and "~". (See Figure R-7 below)



Figure R-5
DP-1A
Terminal Block

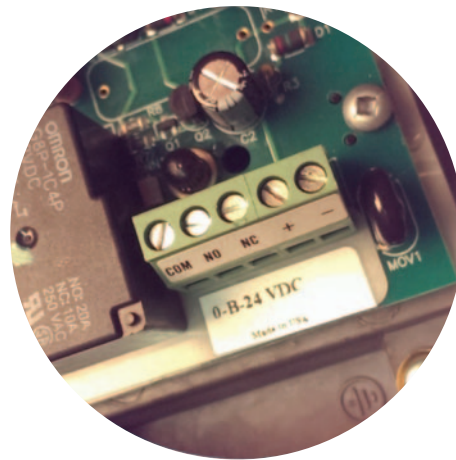

Figure R-6
DP-1B
Terminal Block



Figure R-7
DP-1C and DP-1D
Terminal Block

INSTALLATION for Pressure Switch

I. Adjusting the set-point on the pressure switch:

Remove the plastic cap and turn the slotted adjustment screw (Figure R-8) clockwise to raise the set-point pressure and counter-clockwise to lower the set-point pressure.

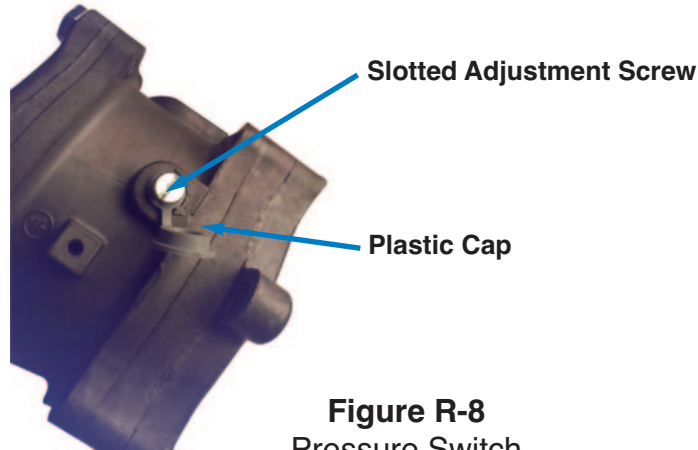

Figure R-8
Pressure Switch
Slotted Adjustment Screw

J. Connect electrical conduit to pressure switch:

The pressure switch has a 1/2" NPTF electrical conduit connection. The customer is responsible for the cable entry device. Cable entry device shall be of certified flameproof type, suitable for the conditions of use and be correctly installed. (See Figure R-9 for location of conduit entry.)

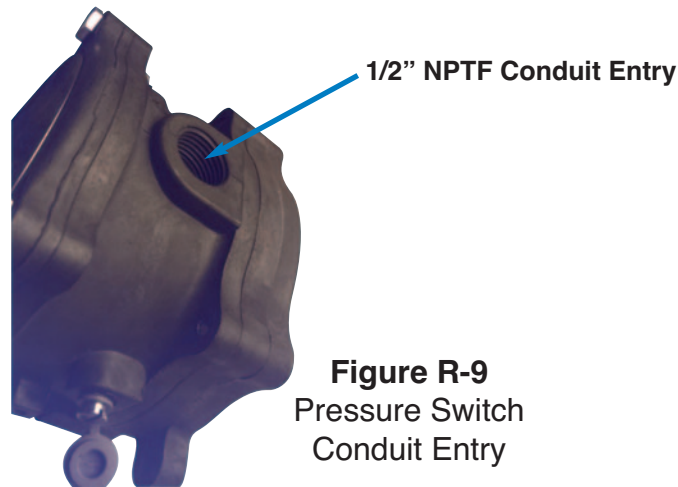

Figure R-9
Pressure Switch
Conduit Entry

K. Checking calibration of pressure switch set-point:

The recommended procedure for calibrating or checking calibration is to use a "T" assembly with three rubber tubing leads – all as short as possible and the entire assembly providing minimum flow restriction. Run one lead to the pressure switch, another to a manometer of known accuracy and appropriate range, and then apply pressure through the third tube. Turn the slotted set-point adjustment screw very slowly as the set-point is approached.

INSTALLATION

Step I-6

A. Calculate the minimum fast purge time for the AFP-01/Enclosure combination:

Use the recommended purge cycle times for the specific volume of the electrical enclosure (see following table).

NOTE: This information is also on the warning label shown on the previous page

	Fast Purge Cycle Times
AFP-01	1 minute per 1.5 cubic feet of enclosure volume
	(For motors, generators, and other rotating electric machinery): 1 minute per 0.6 cubic feet of enclosure volume

Example No. 1: If the electrical enclosure is 24 inches x 30 inches x 12 inches, the volume is 8,640 cubic inches or 5 cubic ft. ($8640 \text{ in}^3 / 1728 \text{ in}^3/\text{ft}^3 = 5 \text{ ft}^3$). Therefore the total fast purge time is 3 minutes and 20 seconds. ($5 \text{ ft}^3 / 1.5 \text{ ft}^3/\text{minute} = 3.33 \text{ minutes}$ or 3 minutes and 20 seconds.)

Example No. 2 (For enclosures with motors, generators, or other rotating electric machinery): If the electrical enclosure is 36 inches x 48 inches x 12 inches, the volume is 20,736 cubic inches or 12 cubic ft. ($20,736 \text{ in}^3 / 1728 \text{ in}^3/\text{ft}^3 = 12 \text{ ft}^3$). Therefore the total fast purge time is 3 minutes and 20 seconds. ($12 \text{ ft}^3 / 0.6 \text{ ft}^3/\text{minute} = 20 \text{ minutes}$.)

Note: If using Nitrogen to purge, the purge time is increased by 3%. As in example No. 2, the purge time will be 20.6 minutes.

INSTALLATION

B. Permanently inscribe the time on the warning label shown below.

Please Note:

1. For Y-Type Purge and Pressurization applications, warning labels applied to the protected enclosure must be metal. The metal warning labels are included with the installation kit.

2. For Z-Type Purge and Pressurization applications, warning labels applied to the protected enclosure are metalized adhesive labels. These labels are included with the installation kit.



Note:
For UL certified units, with applications in Canada, a French Language Warning Label will be included in the installation kit. See page 39D in the appendix.

User to permanently inscribe number of minutes in this space

Figure F-8
Warning Label
to be installed on the enclosure
in a readily visible location
(Label included in the AFP-01 installation kit)

OPERATION



The purchaser is solely responsible for ensuring that their system, including the electrical enclosure, is in conformance with applicable codes. These instructions only cover the general applicability of the AB-CO PURGE Type-Y or Type-Z purge and pressurization systems and relief valves. Specific installation must be approved by the governing code body or bodies.

NOTE:

1. The primary adjustments for the AFP-01 are located on the front panel
2. The AFP-01 uses only manually adjusted pneumatic components to control the purging function. The enclosure pressure gauge is pneumatic and provides a visual indication of low-normal-high enclosure pressure

Step O-1



During operational set-up, it is extremely important that the electrical enclosure is de-energized – there must be no power into the enclosure.
(As stated in Installation “Step I-1”, AB-CO PURGE suggests the customer have an effective “Lock-Out/Tag-Out” system in place in order to ensure all safety precautions are addressed.)

Step O-2

Verify the supply line pressure of instrument air or inert gas does exceed 195 psi.

Concurrently, the size and flow capacity of the supply line must be sufficient so that, under service conditions, the AFP-01 system is not “starved” – i.e., under peak flow conditions for the system, the inlet pressure must not drop below 60 psig.

OPERATION

Step O-3

Close the Fast Purge Control Valve (See Figure F-9 below which shows valve handle in the closed position). The Fast Purge Control Valve is a quarter-turn ball valve and is opened during the purging operation.

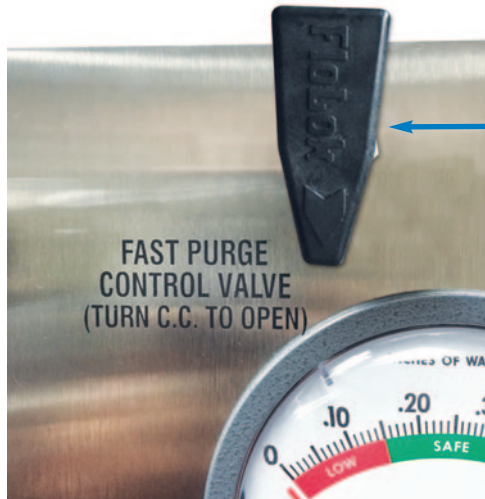
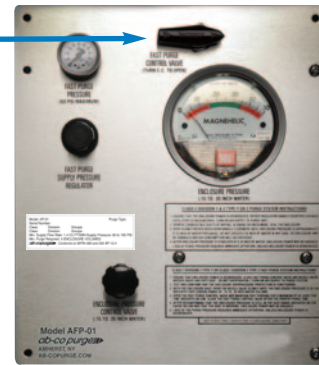

Figure F-9
Fast Purge Control Valve in
Closed position



AFP-01 Front Panel

Step O-4

Close the Enclosure Pressure Control Valve

The valve is a fine adjustment needle valve used to set the pressure for the protected enclosure.



Figure F-10
Enclosure Pressure
Control Valve

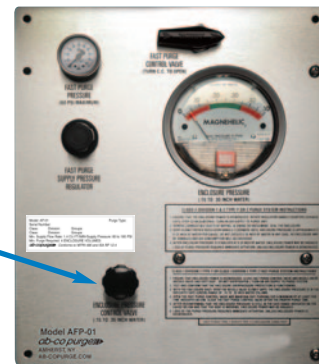

AFP-01 Front Panel



The purchaser is solely responsible for ensuring that their system, including the electrical enclosure, is in conformance with applicable codes. These instructions only cover the general applicability of the AB-CO PURGE Type-Y or Type-Z purge and pressurization systems and relief valves. Specific installation must be approved by the governing code body or bodies.

OPERATION

Step O-5

Open the Fast Purge Supply Pressure Regulator. (See Figure F-11)

The Fast Purge Supply Pressure Regulator is connected to the instrument air or inert gas supply line and controls the air pressure from the supply source to the AFP-01 purge and pressurization system.

Supply pressure is not to exceed 195 psi.

The Fast Purge Supply Pressure Regulator controls the pressure in the AFP-01 so that the flow performance is consistent.

Note: A locking ring is under the knob of the Fast Purge Supply Pressure Regulator. Pulling out the knob releases the lock and allows the knob to be turned. Pushing in the knob locks it in the set position.



Figure F-11
Fast Purge Supply
Pressure Regulator

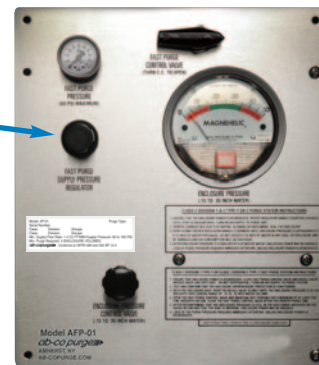

AFP-01 Front Panel

OPERATION

Step O-6

Using the Fast Purge Supply Pressure Regulator, dial in the pressure to a maximum pressure of 60 psig on the Fast Purge Pressure Gauge (See Figure F-12 below).

The Fast Purge Supply Pressure Regulator controls the pressure in the AFP-01 so that the flow performance is consistent. The Fast Purge Pressure Gauge indicates the output pressure for the Fast Purge Supply Pressure Regulator.

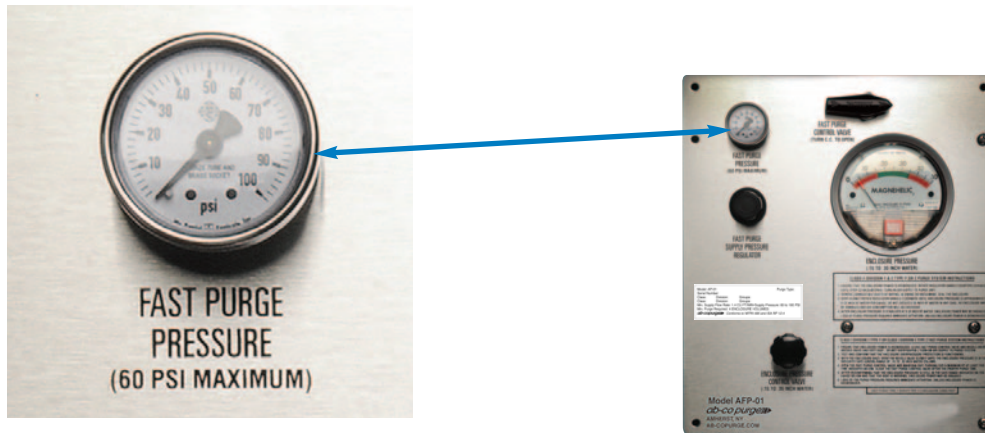

Figure F-12
Fast Purge Pressure
Gauge

AFP-01 Front Panel

Step O-7

(NOTE: For Class II areas only)

Remove combustible dusts from inside the protected enclosure by wiping, blowing, or vacuuming

Step O-8

With power still off, close the protected electrical enclosure and secure as it would be during normal operation.

OPERATION

Step O-9

Open the Fast Purge Control Valve by rotating one quarter turn in the counter-clockwise direction. (See Figure F-13 below with Fast Purge Control Valve in the “OPEN” position).

Opening the Fast Purge Control Valve at this stage of the operation is vital to removing any ambient air captured within the enclosure. This is the actual purge process during which time clean instrument air or inert gas is being cycled into the enclosure.

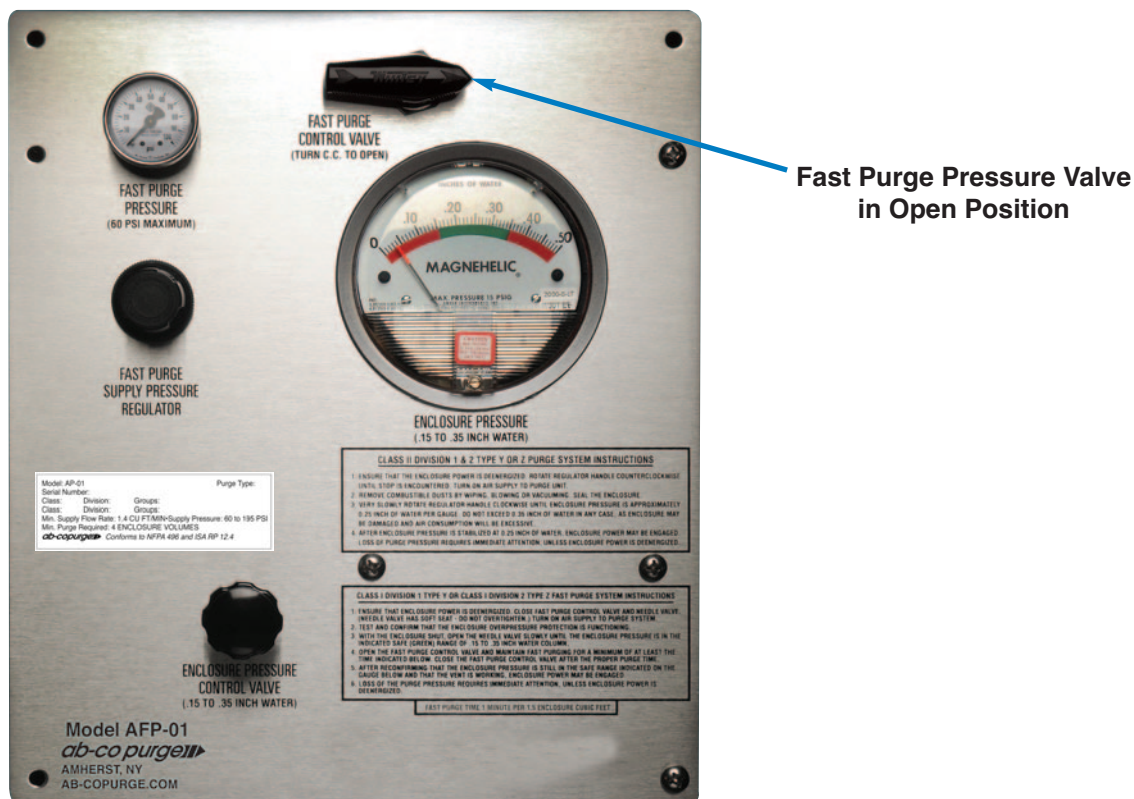
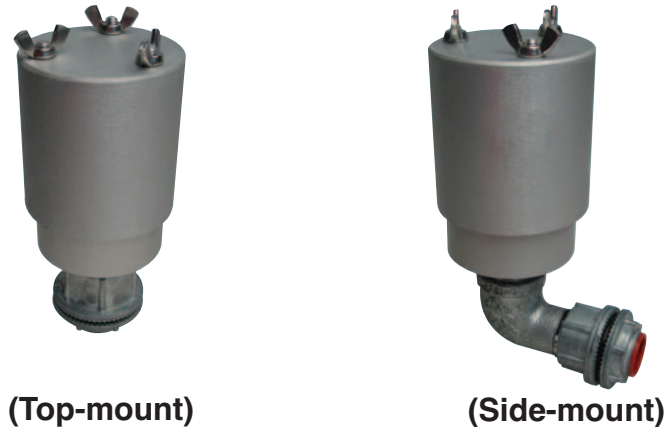

Figure F-13
AFP-01 Front Panel
with Fast Purge Pressure Valve
in Open Position

OPERATION

Step O-10

Ensure the vent (pressure relief valve) is functioning. As fast purge pressurized air is flowing into the electrical enclosure, air should be escaping through the vent. This is because the volume of air during the purging operation is much greater than the amount of air flowing during the continuous pressurization process. Figure F-14 below shows the two configurations of vents.



(Top-mount)

(Side-mount)

Figure F-14
Vent Configurations

Note: The AFP-01 is leakage compensated by providing high protective gas volumes to quickly purge concentrations of combustible gas from the electrical enclosure and then providing lower volumes sufficient to maintain a pressure inside the enclosure that is greater than the surrounding hazardous environment – thus compensating for any leakage from the enclosure.

Step O-11

Close the Fast Purge Control Valve after completing the fast purge cycle. (See Figure F-15 below which shows valve handle in the closed position).

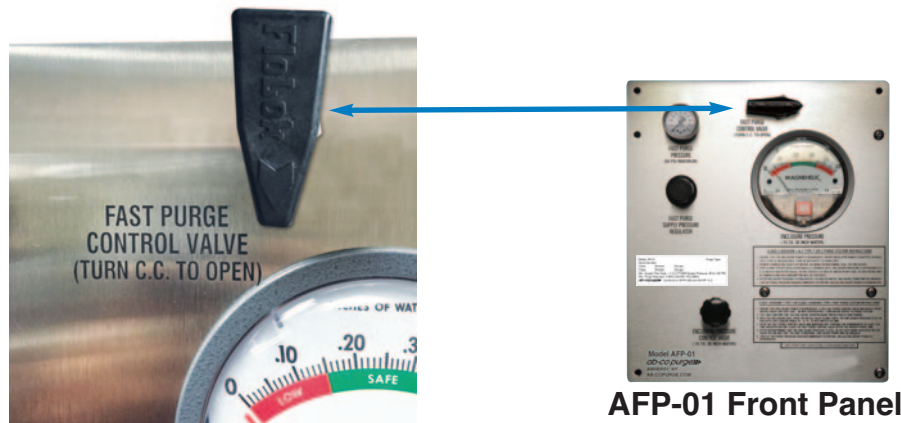

Figure F-15
Fast Purge Control Valve in
Closed position

AFP-01 Front Panel

Note: When the Fast Purge Control Valve is closed the needle on the Enclosure Pressure Gauge may be pegged at the high end. This will not damage the gauge since there is a pressure drop when the valve is closed due to the enclosure pressure relief vent.

OPERATION

Step O-12

Set the enclosure pressure by adjusting the Enclosure Pressure Control Valve (See Figure F-16 below)

Correct adjustment places the needle of the Enclosure Pressure Gauge (See Figure F-17 below) within the required (green area of the Magnehelic analog gauge) safe setting.

The AFP-01's purge pressure setting is 0.25 inches of water.

The safe range as scaled on the Enclosure Pressure Gauge is 0.15 inches of water to 0.35 inches of water.

The Enclosure Pressure Control Valve is a fine adjust needle valve. Prior to adjustment it may be opened or closed. This valve controls the purge flow rate and thus pressure in the enclosure during normal operations. NFPA 496 specifies that purge pressure must be maintained so that the enclosure pressure is at least 25 Pa (0.10 inches of water).

As stated above, a purge pressure of 0.25 inches of water represents a reasonable pressure which gives a safety margin above the required minimum to allow for supply air pressure and enclosure leakage variations. These limits are inside those prescribed by NFPA 496 which requires the protected enclosure be constantly maintained at a positive pressure of at least 25 Pa (0.10 inches of water) above the surrounding atmosphere during operation of the protected equipment.

Higher pressures should be avoided to minimize air use and keep enclosure distortion possibilities at a minimum.

Caution: The Enclosure Pressure Control Valve has a soft seat and must not be over tightened. Over tightening this valve will damage the valve.



Figure F-16
Enclosure Pressure Control Valve

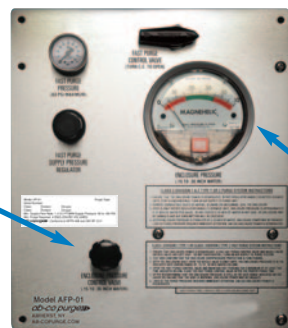

AFP-01 Front Panel

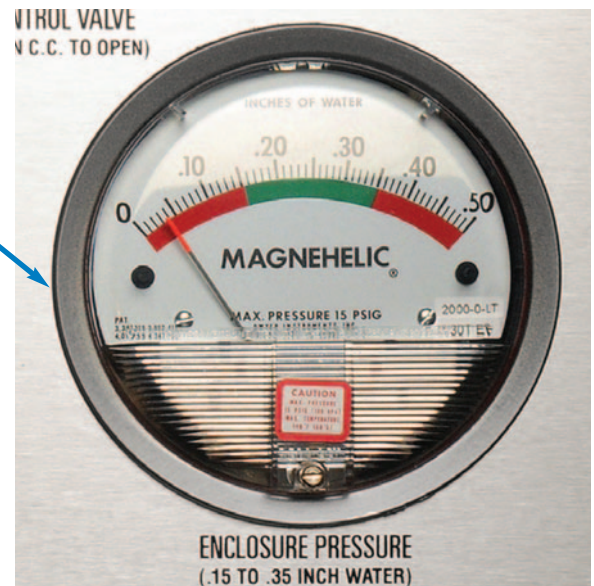

Figure F-17
Enclosure Pressure Gauge (Visual Indicator)

OPERATION

Step O-13

Turn Power on to the Enclosure – Ensure Lock-out/Tag-out has been properly checked prior to energizing the enclosure.

Step O-14



Loss of enclosure pressure to a level below 0.15 inches of water requires immediate attention including de-energizing enclosure power (unless power has already been de-energized).

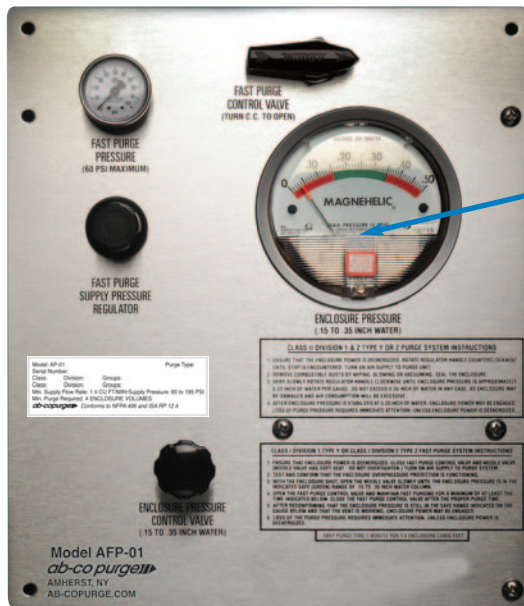

Enclosure pressure gauge with visual indication that enclosure pressure is below 0.15 inches of water – **ACTION REQUIRED – De-energize the enclosure.** (If Not Already De-Energized)

Figure F-18

Enclosure Pressure Gauge Indication



Note: Do not let the enclosure pressure exceed 0.35 inches of water in any case, as protected enclosure may be damaged and air consumption will be excessive. (Visual indication of over pressure is shown as the red section on the enclosure pressure gauge in the range of 0.35 inches of water to 0.50 inches of water.)



Warning.....Your electrical enclosure is protected by pressurization. The pressurized enclosure shall not be opened unless the area atmosphere is known to be below the ignitable concentration of combustible material or unless all internal non-explosive protected devices have been de-energized.

Power shall not be restored to pressurized enclosures after the enclosure has been opened until the enclosure has been purged for a minimum of 4 enclosure volumes with a protected gas (ten volumes for motors, generators, and other rotating electrical machinery) at a flow rate of **6 cubic feet per minute**. Refer to the red warning label on the enclosure to determine how long the enclosure needs to be purged. (See page 23.)

PRODUCT DATA SHEETS

Detailed product data sheets for AFP-01, Type-Y and Type-Z Purge and Pressurization Systems are available on the AB-CO PURGE web site at www.AB-COPURGE.com



Figure F19

Example: AFP-01 Mounted to the left side of an electrical enclosure with top-mounted vent and required warning label (in red).

(Note electrical conduit running from optional pressure switch to enclosure. The customer decides what kind of pressure switch to use and also what additional visual indicators to use – i.e., the red/amber/green indicator light on top of this enclosure example.)

Instructions on AFP-01 Control Panel

CLASS II DIVISION 1 TYPE Y OR CLASS II, DIVISION 2 TYPE Z PRESSURIZATION SYSTEM INSTRUCTIONS

1. ENSURE THAT THE ENCLOSURE POWER IS DE-ENERGIZED. ROTATE REGULATOR HANDLE COUNTERCLOCKWISE UNTIL STOP IS ENCOUNTERED. TURN ON AIR SUPPLY TO PURGE UNIT.
2. REMOVE COMBUSTIBLE DUSTS BY WIPING, BLOWING, OR VACUUMING. SEAL THE ENCLOSURE.
3. VERY SLOWLY ROTATE REGULATOR HANDLE CLOCKWISE UNTIL THE ENCLOSURE PRESSURE IS APPROXIMATELY 0.25 INCH OF WATER PER GAUGE. DO NOT EXCEED 0.35 INCH OF WATER IN ANY CASE, AS ENCLOSURE MAY BE DAMAGED AND AIR CONSUMPTION WILL BE EXCESSIVE.
4. AFTER ENCLOSURE PRESSURE IS STABILIZED AT 0.25 INCH OF WATER, ENCLOSURE POWER MAY BE ENGAGED. LOSS OF PURGE PRESSURE REQUIRES IMMEDIATE ATTENTION, UNLESS ENCLOSURE POWER IS DE-ENERGIZED.

CLASS I DIVISION 1 TYPE Y OR CLASS II, DIVISION 2 TYPE Z PURGE SYSTEM INSTRUCTIONS

1. ENSURE THAT ENCLOSURE POWER IS DE-ENERGIZED. CLOSE FAST PURGE CONTROL VALVE AND NEEDLE VALVE. (NEEDLE VALVE HAS SOFT SEAT – DO NOT OVER TIGHTEN.) TURN ON AIR SUPPLY TO PURGE SYSTEM.
2. TEST AND CONFIRM THAT THE ENCLOSURE OVER PRESSURE PROTECTION IS FUNCTIONING.
3. WITH THE ENCLOSURE SHUT, OPEN THE NEEDLE VALVE SLOWLY UNTIL THE ENCLOSURE PRESSURE IS IN THE INDICATED SAFE (GREEN) RANGE OF 0.15 TO 0.35 INCHES WATER COLUMN.
4. OPEN THE FAST PURGE CONTROL VALVE AND MAINTAIN FAST PURGING FOR A MINIMUM OF AT LEAST THE TIME INDICATED BELOW. CLOSE THE FAST PURGE CONTROL VALVE AFTER THE PROPER PURGE TIME.
5. AFTER RECONFIRMING THAT THE ENCLOSURE PRESSURE IS STILL IN THE SAFE RANGE INDICATED ON THE GAUGE BELOW AND THAT THE VENT IS WORKING, ENCLOSURE POWER MAY BE ENGAGED.
6. LOSS OF THE PURGE PRESSURE REQUIRES IMMEDIATE ATTENTION. UNLESS ENCLOSURE POWER IS DE-ENERGIZED.

FAST PURGE TIME 1 MINUTE PER 1.5 ENCLOSURE CUBIC FEET

FOR MOTORS, GENERATORS, AND OTHER ROTATING ELECTRIC MACHINERY FAST PURGE TIME 1 MINUTE PER 0.6 ENCLOSURE CUBIC FEET

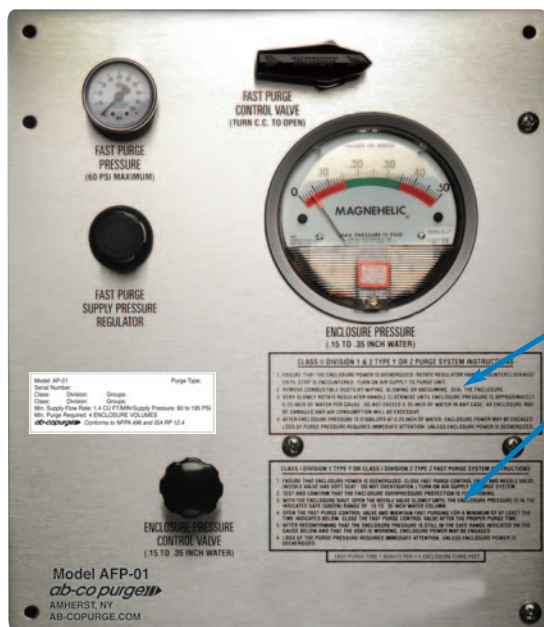

Above AFP-01 Instructions Located on Front Panel

Figure F-20
AFP-01 Front Panel with Instructions

AFP-01 Product Configuration Code

All AFP-01 Type-Y and Type-Z Purge and Pressurization Systems adhere to a “ConfigurationCode” that is used by both the customers and AB-CO PURGE sales/service when ordering or servicing these respective systems. In all cases, these order codes start with the “AFP-01” designations and every product with this designation in the order code adheres to the installation and operations instructions contained within this manual.

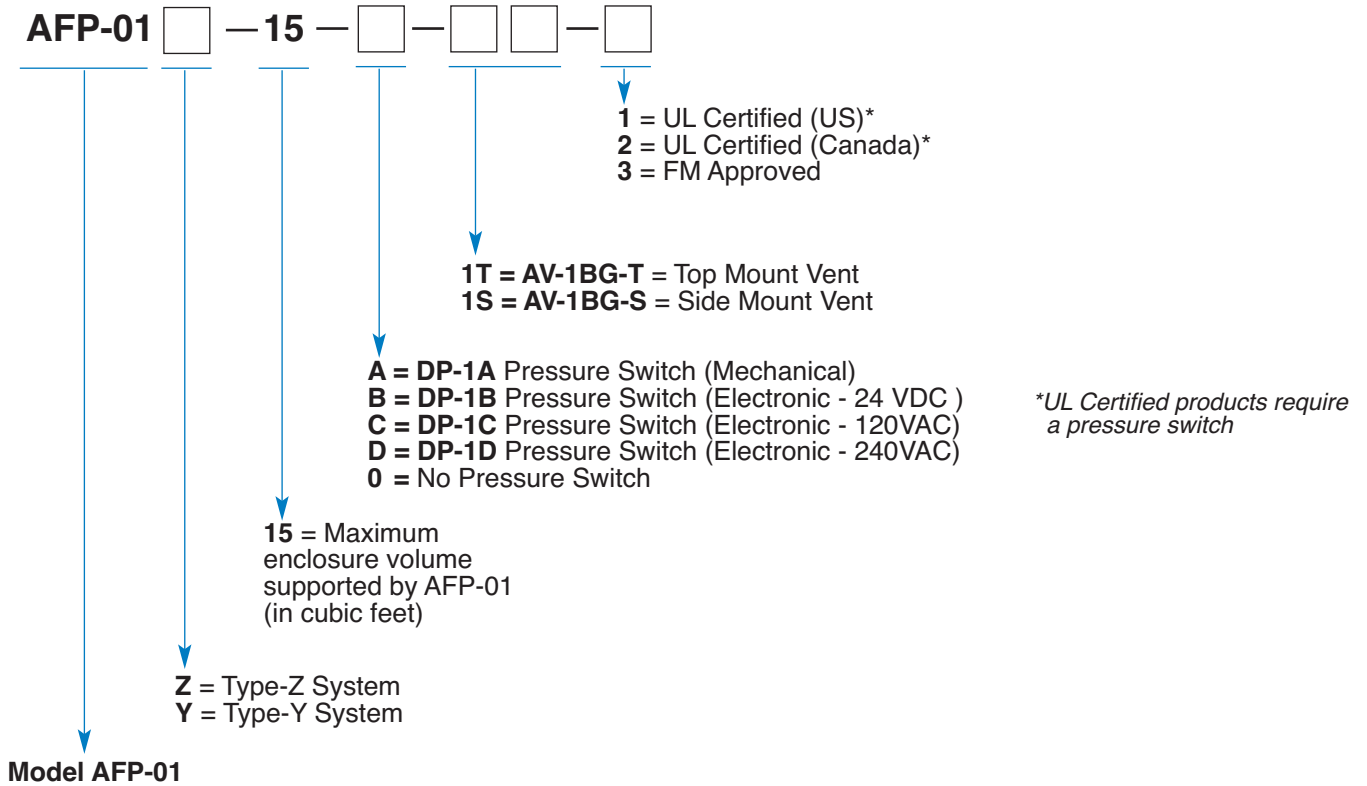

Example:

A configuration code of **AFP-01Z-15-B-1T-1** designates a Model AFP-01 Type-Z purge and pressurizations system which is designed for a maximum enclosure volume of 15 cubic feet. The front panel is standard with a universal mounting bracket (for mounting on either side or top or bottom of the enclosure). This system has the DP-1B pressure switch with a top-mount vent and UL certification for US applications.

ab-copurge SYSTEM – Selection Checklist

The following checklist can be used as an aid to determine applicability of your current system or for specifying a future system. Completing this checklist can assist AB-CO PURGE’s technical sales staff to assist you in the selection of your next purge and pressurization system.

- I.** The area classification in which the purged enclosure(s) will be installed
- NEC Class/Division System:** **NEC & IEC Zone System:**
- Class: _____ Zone: _____
- Division: _____ Group(s): _____
- Group(s): _____

- II.** Volume (Length X Width X Height) of each enclosure to be purged and pressurized
- L x W x H = _____ (in cubic dimensional units;
i.e. cubic inches, cubic feet, cubic centimeters, etc.)
- List additional enclosure volumes as required:
- _____
- _____

- III.** Type of enclosure to be purged and pressurized:
- _____
- _____
- Does the electrical enclosure have a NEMA rating?
 Yes No
 If “Yes”, please give the rating (i.e., NEMA 4, NEMA 12, etc.):
- _____

Give the material the enclosure is constructed of:

- III.** The lowest rated piece of equipment going into the enclosure(s):
- _____
- (For example: Unclassified; Class I, Division 1 : Class I, Division 2; Class II, Division 1; Class II, Division 2; etc.)*

- Type of purge and pressurization system needed:
- Y Purge
- Z Purge
- X Purge *(Type X Systems are not currently available from AB-CO PURGE)*

- VI.** Will you use a single purge and pressurization system for one or multiple enclosures?
- NO... A separate system required for each enclosure
- YES... A single system will be used for multiple enclosures
- OTHER... A combination of systems with multiple enclosures

- VII.** Mounting of the purge and pressurization system:
- Left side Right side Top Bottom

- VIII.** Location of vent (relief valve):
- Top Mounted Side Mounted

- IX.** If the optional pressure switch is used, depending on the type of switch, signal from and power to is required. Is there signal/power accessible within or outside the enclosure?
- Yes...within the electrical enclosure
- Yes...outside the electrical enclosure (In this case, ensure conduit connections meet required standards for hazardous environments).

- DP-1A pressure switch has signal out (not power to the switch)
- DP-1B pressure switch has signal out and requires 24 VDC supply
- DP-1C pressure switch has signal out and requires 120 VDC supply
- DP-1D pressure switch has signal out and requires 240 VDC supply

(Note: The optional pressure switch provides capability for remote visual (and/or audio) indication of enclosure pressure.

- X.** What is the maximum supply pressure of the instrument air or inert gas?

_____ psig
(Note: Maximum allowed pressure is 250 psig.)

- XI.** Is there a “Lock-Out/Tag-Out” system in location of enclosure?
- Yes No

- XII.** Certification(s) Required
- UL (US) FM (US)
- UL (Canada) FM (Canada) IECex

Appendix

CERTIFICATE OF COMPLIANCE

Certificate Number 20170802-E490810
Report Reference E490810-20170728
Issue Date 2017-AUGUST-02

Issued to: AB-CO PURGE
320 Creekside Drive
Amherst NY 14228

This is to certify that representative samples of PURGING AND PRESSURIZING CONTROLS AND ACCESSORIES FOR USE IN HAZARDOUS LOCATIONS
See addendum page

Have been investigated by UL in accordance with the Standard(s) indicated on this Certificate.

Standard(s) for Safety: NFPA 496 - Standard for Purged and Pressurized Enclosures for Electrical Equipment

Additional Information: See the UL Online Certifications Directory at www.ul.com/database for additional information

Only those products bearing the UL Certification Mark should be considered as being covered by UL's Certification and Follow-Up Service.

Look for the UL Certification Mark on the product.



Bruce Mahrenholz, Director North American Certification Program
UL LLC

Any information and documentation involving UL Mark services are provided on behalf of UL LLC (UL) or any authorized licensee of UL. For questions, please contact a local UL Customer Service Representative at <http://ul.com/aboutul/locations/>



Appendix

RFPW7.E490810 - PURGING AND PRESSURIZING CONTROLS AND ACCESSORIES FOR USE IN HAZARDOUS LOCATIONS CERTIFIED FOR CANADA

Purging and Pressurizing Controls and Accessories for Use in Hazardous Locations Certified for Canada

See General Information for Purging and Pressurizing Controls and Accessories for Use in Hazardous Locations Certified for Canada

AB-CO PURGE

E490810

320 CREEKSIDE DRIVE
AMHERST, NY 14228 USA

Purging and pressurizing controls, Type Y, Models *AFP-01*, *AFP-02*, and *AFP-03* for use in Class I, Division 1, Groups A, B, C, and D; Class II, Groups F and G Hazardous Locations when assembled with Cat. No. 1950G pressure switch.

Type Y, Models *AFP-01*, *AFP-02*, and *AFP-03* for use in Class I, Division 1, Groups C and D; Class II, Groups F and G Hazardous Locations when assembled with Cat. No. 1950 pressure switch.

Type Z, Models *AP-01*, *AFP-01*, *AFP-02*, and *AFP-03* for use in Class I, Division 2, Groups A, B, C, and D; Class II, Groups F and G Hazardous Locations when assembled with Cat. No. 1950G pressure switch.

Type Y, Models *AP-01*, *AFP-01*, *AFP-02*, and *AFP-03* for use in Class I, Division 2, Groups C and D; Class II, Groups F and G Hazardous Locations when assembled with Cat. No. 1950 pressure switch.

Last Updated on 2017-08-04

The appearance of a company's name or product in this database does not in itself assure that products so identified have been manufactured under UL's Follow-Up Service. Only those products bearing the UL Mark should be considered to be Certified and covered under UL's Follow-Up Service. Always look for the Mark on the product.

UL permits the reproduction of the material contained in the Online Certification Directory subject to the following conditions: 1. The Guide Information, Assemblies, Constructions, Designs, Systems, and/or Certifications (files) must be presented in their entirety and in a non-misleading manner, without any manipulation of the data (or drawings). 2. The statement "Reprinted from the Online Certifications Directory with permission from UL" must appear adjacent to the extracted material. In addition, the reprinted material must include a copyright notice in the following format: "© 2019 UL LLC"

Appendix

NOT to be distributed outside the FACTORY MUTUAL SYSTEM, except by CLIENT.

APPROVAL REPORT

**MODELS AP-01a, AFP-01a, AFP-02a AND AFP-03a
TYPE Z & Y PRESSURIZING SYSTEMS
FOR HAZARDOUS (CLASSIFIED) LOCATIONS**

Prepared For:

**AB-CO Controls Inc.
804 Park Two Drive
Sugarland, Texas 77478**

**J.I. 3002170
(3620)
April 7, 1999**

FACTORY MUTUAL | 

1151 Boston-Providence Turnpike
P.O. Box 9102
Norwood, Massachusetts 02062

Full Documentation can be viewed on our website: ab-copurge.com

Appendix

ANSI/NFPA 496

WARNING

ISA-RP 12.4

THIS ENCLOSURE IS PROTECTED BY PRESSURIZATION

THE PRESSURIZED ENCLOSURE SHALL NOT BE OPENED UNLESS THE AREA ATMOSPHERE IS KNOWN TO BE BELOW THE IGNITABLE CONCENTRATION OF COMBUSTIBLE MATERIALS OR UNLESS ALL INTERNAL NON-EXPLOSIVE PROTECTED DEVICES HAVE BEEN DE-ENERGIZED. POWER SHALL NOT BE RESTORED TO PRESSURIZED ENCLOSURE AFTER THE ENCLOSURE HAS BEEN OPENED UNTIL THE ENCLOSURE HAS BEEN PURGED FOR A MINIMUM OF 4 ENCLOSURE VOLUMES WITH A PROTECTED GAS (TEN VOLUMES FOR MOTORS, GENERATORS, AND OTHER ROTATING ELECTRIC MACHINERY) AT A FLOW RATE OF 6 CUBIC FT./MIN. OR 1 MINUTE/1.5 CUBIC FT. OF ENCLOSURE VOLUME (1 MINUTE/0.6 CUBIC FEET OF ENCLOSURE VOLUME FOR MOTORS, GENERATORS, AND OTHER ROTATING ELECTRICAL MACHINERY).

FOR THIS ENCLOSURE VOLUME PURGE FOR MINUTES.

WARNING

IF PROTECTIVE GAS IS OTHER THAN AIR, PROTECTIVE GAS RELEASE POSES POTENTIAL FOR ASPHYXIATION.

WARNING

FOR CLASS II AREAS: POWER MUST NOT BE RESTORED AFTER THE ENCLOSURE HAS BEEN OPENED UNTIL COMBUSTIBLE DUSTS HAVE BEEN REMOVED AND THE ENCLOSURE REPRESSURIZED.

Warranty Statement

a. Company warrants its Goods to be free from material defects in material and workmanship except:

- i. when Goods have been modified following delivery and/or subject to improper handling, storage, installation, operation, or maintenance.
- ii. when an item is purchased by Company as a component part of the Goods, except to the extent to which such item or items are covered by the warranty, if any, of the original manufacturer.
- iii. when an item which is a component part of the product has been furnished by Buyer.
- iv. no warranty of a component part shall extend beyond the warranty period of the device in which such component part is incorporated.

b. There is no implied warranty of merchantability or of fitness for particular purpose and there are no warranties of any nature except as set forth in paragraph 3 herein. Any claim by Buyer made pursuant to Company's warranty must be made in writing. Company shall have the right to inspect the Goods claimed to be defective and shall have the right to determine the cause of such alleged defect. All Goods replaced or repaired by Company under its warranty shall be replaced or repaired F.O.B. Company's plant. Buyer must notify Company, in writing, within fifteen (15) days from receipt of Goods of any obvious defect in the product or shortages, or Company shall have no obligation to correct such defect. Company shall have the option of re-inspection at Buyer's plant or its own before allowing or disallowing Buyer's claim. Defects that do not impair service shall not be a cause for rejection or recovery under any warranty. Buyer assumes full responsibility for the use and application of the product. Buyer accepts Company's design and material selection and specifications in placing this order unless other specifications are agreed to in writing by both parties prior to the manufacture of Goods by Company.

PLEASE OBTAIN A RETURNS GOODS AUTHORIZATION NUMBER (RMA) BEFORE SHIPPING ANY WARRANTY ITEM TO AB-CO PURGE. OUR PHONE NUMBER IS 716-500-ABCO. ALL SHIPMENTS WILL BE AT THE CUSTOMERS EXPENSE. SHIPMENTS WILL BE SENT TO THE FOLLOWING ADDRESS.

AB-CO PURGE • 320 Creekside Drive • Amherst, NY 14228, USA



*Due to the nature of technology, changes are inevitable.
For latest technical specifications, see our website.*

Contact Us
Tel: 716.500.abco